

## Verdrahtungskanal, Typ LK4 60060



Verdrahtungskanal inkl. Oberteil und Bodenlochung.

Typ	Farbe	Länge mm	Ab- messung B x H mm	Verp. m	Gewicht kg/100 m	Art.-Nr.
LK4 60060	steingrau	2000	60x60	32	64,500	6178 03 3

**PVC** Polyvinylchlorid

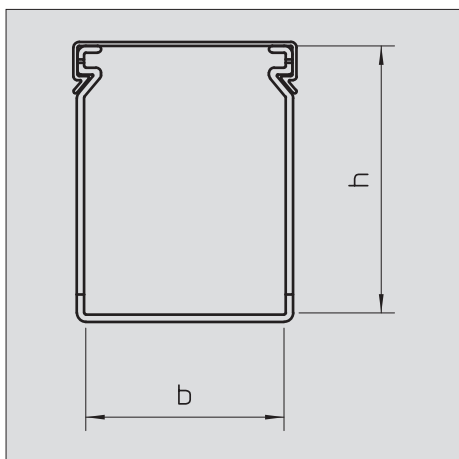

CE