

## Verdrahtungskanal, Typ LK4 80040

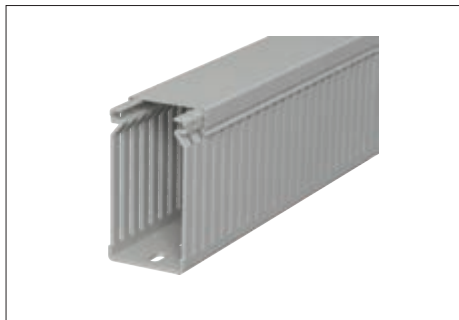

Verdrahtungskanal inkl. Oberteil und Bodenlochung.

Typ	Farbe	Länge mm	Ab- messung B x H mm	Verp. m	Gewicht kg/100 m	Art.-Nr.
LK4 80040	steingrau	2000	40x80	24	64,500	6178 05 2

**PVC** Polyvinylchlorid

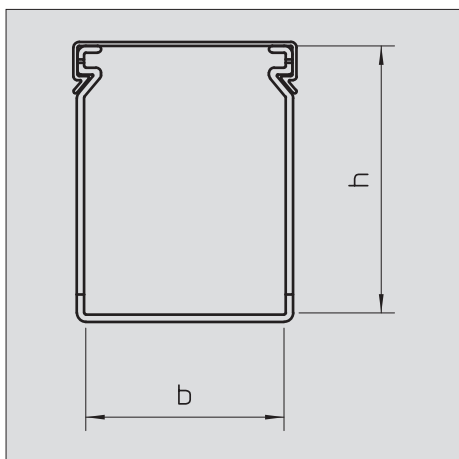

CE