

1 2 3 4 5 6

A

B

C

D

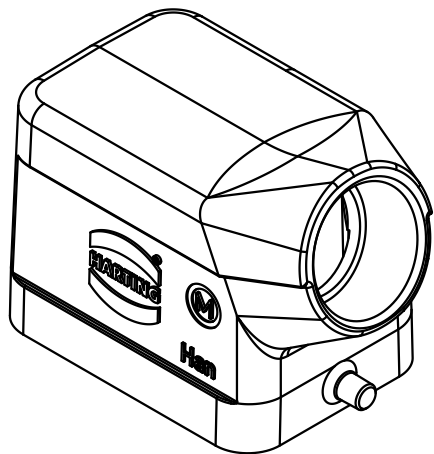
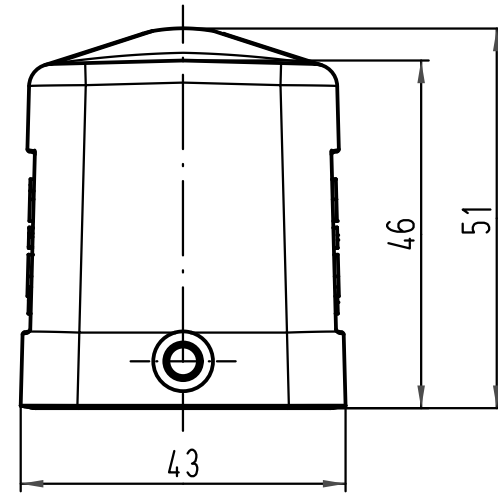
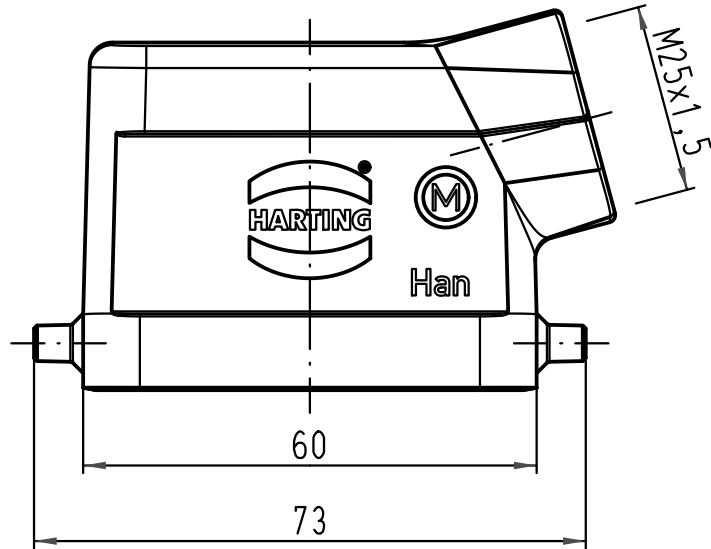

All Dimensions in mm Original Size DIN A 4		Techn. Character.			Nicht tolerierte Maß/Free size tolerances	
			Dat.	Name	Maßstab/Scale 1:1	Han 6B-gs-M25 Tüllengehäuse hood
		Detail.	19.02.09	ML		
		Insp.		Sch		
		Stand.				
B	06.08.09	Spr	HARTING Electric GmbH & Co. KG			TB 19 30 006 1541
A			D-32339 Espelkamp			
Mod.	Dat.	Name				Sub. TB 19 30 006 1541 v. 23.06.06
						Blatt/ page