

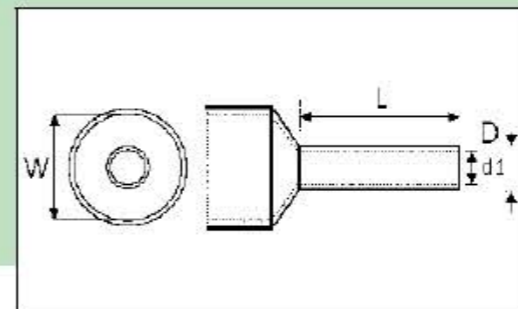









Aderendhülsen für kurzschluss sichere Leitungen

- für kurzschluss sichere Leitungen mit extra dicker Isolierung (NSFGAFÖU)
- Anwendung: Einspeisungen oder Abzweigungen vor dem Hauptschalter, in Schaltanlagen, Verteilern oder auch bei Schienenfahrzeugen, Solaranlagen, Zündkabeln



Art. Nr.	LQ		d1	d2	l	kg/100		VE	
270900	1,5	schwarz	1,8	6,8	8	0,026		100	
270902		schwarz	1,8	6,8	10	0,024		100	
270904	2,5	blau	2,3	7,8	8	0,033		100	
270906		blau	2,3	7,8	12	0,360		100	
270908	4	grau	2,9	7,8	10	0,046		100	
270910	6	gelb	3,8	7,3	12	0,062		100	
270912	10	rot	4,5	9,8	12	0,081		100	
270914	16	blau	6,0	12,2	12	0,107		100	