



## Hauptkenndaten

Produktserie	Harmony XB5
Produkt oder Komponententyp	Kopf für beleuchteten Wahlschalter
Produktkompatibilität	LED-Modul
Kurzbezeichnung des Geräts	ZB5
Blendenmaterial	Kunststoff
Montagedurchmesser	22 mm
Verkauf je unteilbare Menge	1
Form des Signaleinheitkopfes	Rund
Operatortyp	Rastend
Profil Betätigungselement	Weiß Standardgriff
Betriebs-Positionsinformation	3 Positionen +/- 45°

## Zusatzdaten

CAD-Gesamtbreite	29 mm
CAD-Gesamthöhe	29 mm
CAD-Gesamttiefe	43 mm
Produktgewicht	0,016 kg
Mechanische Lebensdauer	1000000 Zyklen
Stationsname	XALD 1-5 Ausschnitte XALK 2-5 Ausschnitte
Code für den elektrischen Aufbau	M10 für <= 2 Kontakte in einfach Blöcke in Frontmontage mit LED-Modul M6 für <= 2 Kontakte in einfach Blöcke in Frontmontage mit LED-Modul und Transformator MF1 für <= 2 Kontakte in einfach Blöcke in Frontmontage mit LED-Modul MR1 für <= 2 Kontakte in einfach Blöcke in rückseitige Montage mit LED-Modul M3 für <= 4 Kontakte in einfach Blöcke in Frontmontage mit LED-Modul M4 für <= 4 Kontakte in einfach und doppelt Blöcke in Frontmontage mit LED-Modul

## Umgebung

Schutzbehandlung	TH
Umgebungstemperatur bei Lagerung	-40-70 °C
Umgebungstemperatur bei Betrieb	-40-70 °C
Überspannungskategorie	Klasse II entspricht IEC 60536
Schutzart (IP)	IP67 IP66 entspricht IEC 60529 IP69K IP69
Schutzart (NEMA)	NEMA 13 NEMA 4X
Widerstandsfähigkeit gegen Hochdruckreiniger	7000000 Pa bei 55 °C, Entfernung: 0,1 m
IK-Schutzart	IK06 entspricht IEC 50102
Normen	EN/IEC 60947-1 EN/IEC 60947-5-1 EN/IEC 60947-5-4 EN/IEC 60947-5-5 JIS C 4520 UL 508 CSA C22.2 No 14
Produktzertifizierungen	BV CSA DNV GL LROS (Lloyds register of shipping)

Die in dieser Dokumentation bereitgestellten Informationen beinhalten allgemeine Beschreibungen und/oder technische Daten und Leistungsmerkmale der entsprechenden Produkte. Diese Dokumentation ist nicht als Ersatz für eine Eignungsbestimmung gedacht und darf nicht dazu verwendet werden, die Eignung oder Zuverlässigkeit dieser Produkte für spezifische Benutzeranwendungen zu bestimmen. Jeder Benutzer oder Integrator ist verpflichtet, geeignete und vollständige Risikoanalysen, Evaluierungen und Tests der Produkte im Hinblick auf die jeweilige spezifische Anwendung oder Verwendung durchzuführen. Weder Schneider Electric Industries SAS noch seine angegliederten Unternehmen sind für den fehlerhaften Gebrauch oder Missbrauch der gelieferten Informationen verantwortlich oder haftbar zu machen.

Vibrationsfestigkeit	5 gn (f = 2...500 Hz) entspricht IEC 60068-2-6
Stoßfestigkeit	30 gn (Dauer = 18 ms) für Sinushalbwellenbeschleunigung entspricht IEC 60068-2-27 50 gn (Dauer = 11 ms) für Sinushalbwellenbeschleunigung entspricht IEC 60068-2-27

## Dimensions

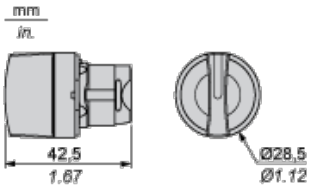

## Panel Cut-out for Pushbuttons, Switches and Pilot Lights (Finished Holes, Ready for Installation)

Connection by Screw Clamp Terminals or Plug-in Connectors or on Printed Circuit Board

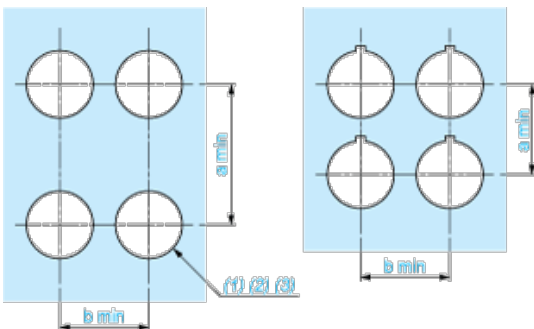

- (1) Diameter on finished panel or support
- (2) For selector switches and Emergency stop buttons, use of an anti-rotation plate type ZB5AZ902 is recommended.
- (3)  $\varnothing 22.5$  mm recommended ( $\varnothing 22.3 \text{ }_0^{+0.4}$ ) /  $\varnothing 0.89$  in. recommended ( $\varnothing 0.88 \text{ in. }_0^{+0.016}$ )

Connections	a in mm	a in in.	b in mm	b in in.
By screw clamp terminals or plug-in connector	40	1.57	30	1.18
By Faston connectors	45	1.77	32	1.26
On printed circuit board	30	1.18	30	1.18

## Detail of Lug Recess

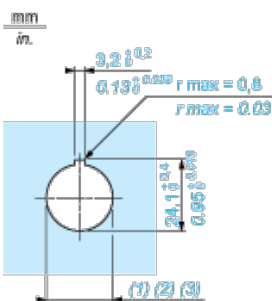

- (1) Diameter on finished panel or support
- (2) For selector switches and Emergency stop buttons, use of an anti-rotation plate type ZB5AZ902 is recommended.
- (3)  $\varnothing 22.5$  mm recommended ( $\varnothing 22.3 \text{ }_0^{+0.4}$ ) /  $\varnothing 0.89$  in. recommended ( $\varnothing 0.88 \text{ in. }_0^{+0.016}$ )

## Pushbuttons, Switches and Pilot Lights for Printed Circuit Board Connection

Panel Cut-outs (Viewed from Installer's Side)

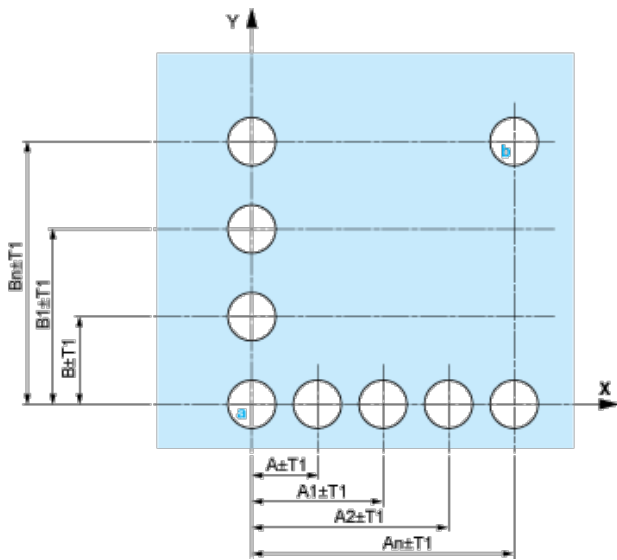

A: 30 mm min. / 1.18 in. min.

B: 40 mm min. / 1.57 in. min.

**Printed Circuit Board Cut-outs (Viewed from Electrical Block Side)**

Dimensions in mm

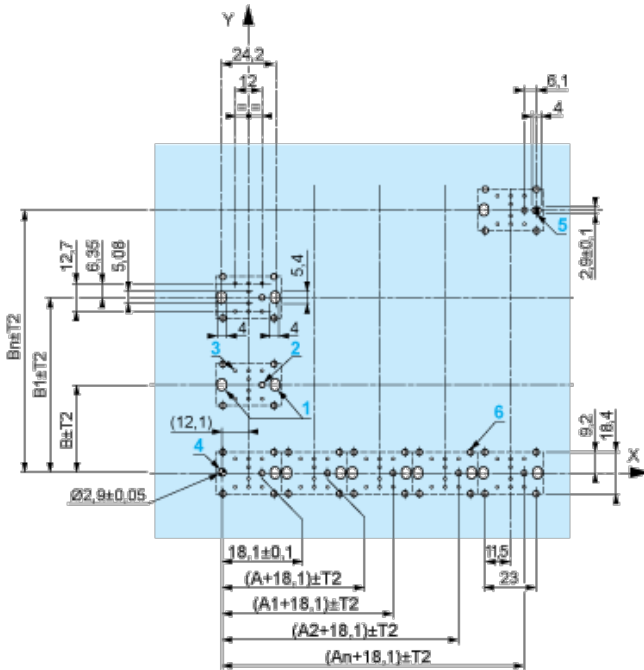

A: 30 mm min.

B: 40 mm min.

Dimensions in in.



A: 1.18 in. min.

B: 1.57 in. min.

### General Tolerances of the Panel and Printed Circuit Board

The cumulative tolerance must not exceed 0.3 mm / 0.012 in.:  $T_1 + T_2 = 0.3 \text{ mm max.}$

### Installation Precautions

- | Minimum thickness of circuit board: 1.6 mm / 0.06 in.
- | Cut-out diameter: 22.4 mm  $\pm$  0.1 / 0.88 in.  $\pm$  0.004
- | Orientation of body/fixing collar ZB5AZ009:  $\pm$  2°30' (excluding cut-outs marked **a** and **b**).
- | Tightening torque of screws ZBZ006: 0.6 N.m (5.3 lbf.in) max.
- | Allow for one ZB5AZ079 fixing collar/pillar and its fixing screws:
  - | every 90 mm / 3.54 in. horizontally (X), and 120 mm / 4.72 in. vertically (Y).
  - | with each selector switch head (ZB5AD•, ZB5AJ•, ZB5AG•).

The fixing centers marked **a** and **b** are diagonally opposed and must align with those marked 4 and 5.



- (1) Head ZB5AD•
- (2) Panel
- (3) Nut
- (4) Printed circuit board

### Mounting of Adapter (Socket) ZBZ01•

- | 1 2 elongated holes for ZBZ006 screw access
- | 2 1 hole  $\varnothing$  2.4 mm  $\pm$  0.05 / 0.09 in.  $\pm$  0.002 for centring adapter ZBZ01•
- | 3 8  $\times$   $\varnothing$  1.2 mm / 0.05 in. holes
- | 4 1 hole  $\varnothing$  2.9 mm  $\pm$  0.05 / 0.11 in.  $\pm$  0.002, for aligning the printed circuit board (with cut-out marked **a**)

- | 5 1 elongated hole for aligning the printed circuit board (with cut-out marked **b**)
- | 6 4 holes  $\varnothing$  2.4 mm / 0.09 in. for clipping in adapter ZBZ01•

Dimensions An + 18.1 relate to the  $\varnothing$  2.4 mm  $\pm$  0.05 / 0.09 in.  $\pm$  0.002 holes for centring adapter ZBZ01•.

### Electrical Composition Corresponding to Code M3

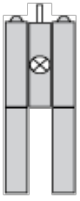

### Electrical Composition Corresponding to Code M4



### Electrical Composition Corresponding to Codes M6 and P2

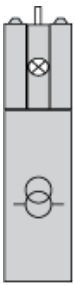

### Electrical Composition Corresponding to Codes M5, M10, MF1, MR1 and MF2

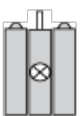

### Legend

Single contact



Double contact



Light block



Possible location



## Sequence of Contacts Fitted to 3-position Selector Switch Body

### Position 315°



<b>Push</b>	Position	Top			
		Bottom			
	Location		Left		Right
	State		1		0
<b>Contacts</b>	N/O		closed	open	
	N/C		open	closed	

### Position 0°



<b>Push</b>	Position	Top			
		Bottom			
	Location		Left		Right
	State		0		0
<b>Contacts</b>	N/O		open	open	
	N/C		closed	closed	

### Position 45°



<b>Push</b>	Position	Top			
		Bottom			
	Location		Left		Right
	State		0		1
<b>Contacts</b>	N/O		open	closed	
	N/C		closed	open	