



Symbolbild



Datenblatt



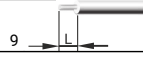

Artikelnummer: 70005136

Bezeichnung: CA20.A202.UE1

Beschreibung: Schalter

IEC 60947-3 EN 60947-3, VDE 0660 Teil 107							
Bemessungsisolationsspannung Ui							
<i>Spannung (V) AC / DC</i>							
690 AC / DC							
Bemessungsdauerstrom Iu/Ith							
<i>Strom (A)</i>	<i>Umgebungstemperatur (°C)</i>	<i>Temperaturspitzen (°C)</i>	<i>zusätzliche Bedingungen</i>				
25	55	60	Umgebungstemperatur +55°C über 24 Stunden mit Spitzen bis +60°C				
Bemessungsbetriebsstrom Ie							
<i>Gebrauchskategorie</i>							
<i>Spannung (V)</i>						<i>Strom (A)</i>	
AC-15						220 - 240	8
AC-15						380 - 440	5
Bemessungsbetriebsleistung							
<i>Gebrauchskategorie</i>							
	<i>Spannung (V)</i>	<i>Phasenanzahl</i>	<i>Polanzahl</i>	<i>Leistung (kW)</i>			
AC-3	220 - 240	3	3	4			
AC-3	380 - 440	3	3	7,50			
AC-3	660 - 690	3	3	7,50			
AC-3	220 - 240	1	2	3			
AC-3	380 - 440	1	2	3,70			
AC-23A	220 - 240	3	3	5,50			
AC-23A	380 - 440	3	3	11			
AC-23A	660 - 690	3	3	11			
AC-23A	220 - 240	1	2	3			
AC-23A	380 - 440	1	2	5,50			
Max. Sicherungsnennstrom IEC							
<i>Sicherungscharakteristik</i>							
<i>Sicherungsanzahl</i>						<i>Strom (A)</i>	
gG						1	35
UL60947-4-1 , UL508							
Nominal Voltage							
<i>Spannung (V) AC / DC</i>							
600 AC							
Bemessungsisolationsspannung Ui							
<i>Spannung (V) AC / DC</i>							
600 AC							
Rated thermal current							
<i>Strom (A)</i>							
30							
<i>Umgebungstemperatur (°C) Zusatz Text</i>							
0 - 40 --							
Horsepower rating							
<i>Across-the-Line Motor Starting</i>							
	<i>Spannung (V)</i>	<i>Phasenanzahl</i>	<i>Polanzahl</i>	<i>Leistung (HP)</i>	<i>Umgebungstemperatur [°C]</i>		
Reversing	110 - 120	1	2	0,33	40		
Reversing	220 - 240	1	2	0,75	40		
Reversing	277 - 277	1	2	1	40		
Reversing	415 - 415	1	2	1,50	40		
Reversing	440 - 480	1	2	2	40		
Reversing	550 - 600	1	2	2	40		
Reversing	110 - 120	3	3	1	40		
Reversing	220 - 240	3	3	2	40		
Reversing	415 - 415	3	3	3	40		
Reversing	440 - 480	3	3	5	40		
Reversing	550 - 600	3	3	5	40		
DOL	110 - 120	1	2	1,50	40		
DOL	220 - 240	1	2	3	40		
DOL	277 - 277	1	2	3	40		
DOL	415 - 415	1	2	3	40		
DOL	440 - 480	1	2	5	40		
DOL	550 - 600	1	2	5	40		
DOL	110 - 120	3	3	3	40		
DOL	220 - 240	3	3	7,50	40		
DOL	415 - 415	3	3	7,50	40		
DOL	440 - 480	3	3	10	40		
DOL	550 - 600	3	3	10	40		

Pilot duty rating code						
Duty Code						
A600						
SCCR / Max. Vorsicherung						
Conditions of acceptability						
These devices are suitable for use on circuits capable of delivering not more than 5000 rms symmetrical amperes, 600V ac max. when protected by Class RK1 fuses. Manual Motor Controllers when intended for use as a motor disconnect are suitable for use on a circuit capable of delivering not more than 5000 rms symmetrical amperes, 600V ac max. when protected by 30A Class J time delay fuses.						
Temp. rating of wire						
Temperature Rating (°C)			Strom (A) Text			
75			– Use copper wire only			
Anschlussbestimmungen						
Markings						
When intended for use as a motor disconnect the device shall be provided with a method of being locked in the OFF-position.						
General Use						
AC / DC	Spannung (V)	Strom (A)	Phasenanzahl	Polanzahl	Anzahl der Kontakte in Serie	
AC	600	30	1	2	1	
AC	600	30	3	3	1	
CSA						
Nominal Voltage						
			Spannung (V) AC / DC			
			600 AC			
Bemessungsisolationsspannung Ui						
			Spannung (V) AC / DC			
			600 AC			
Rated thermal current						
		Strom (A)		Umgebungstemperatur (°C) Zusatz Text		
		30		0 - 40 –		
Horsepower rating						
Across-the-Line Motor Starting						
	Spannung (V)	Phasenanzahl	Polanzahl	Leistung (HP)	Umgebungstemperatur [°C]	
DOL	110 - 120	1	2	1,50	40	
DOL	220 - 240	1	2	3	40	
DOL	277 - 277	1	2	3	40	
DOL	415 - 415	1	2	5	40	
DOL	440 - 480	1	2	5	40	
DOL	550 - 600	1	2	5	40	
DOL	110 - 120	3	3	3	40	
DOL	220 - 240	3	3	7,50	40	
DOL	415 - 415	3	3	10	40	
DOL	440 - 480	3	3	10	40	
DOL	550 - 600	3	3	10	40	
Pilot duty rating code						
Duty Code						
A600						
Temp. rating of wire						
Temperature Rating (°C)			Strom (A) Text			
75			– only			
General Use						
AC / DC	Spannung (V)	Strom (A)	Phasenanzahl	Polanzahl	Anzahl der Kontakte in Serie	
AC	600	30	1	1	1	
GENERAL TECHNICAL INFORMATION						
Leiterquerschnitt						
Leiteraufbau	Min. / Max. Wert	Anzahl der Leiter pro Klemme		Drahtquerschnitt (-bereich) (mm ²) oder (AWG/kcmil)	Drahtmaterial	
eindrähtig	Min.			1 0,75mm ²	Kupfer	
eindrähtig	Min.			2 0,75mm ²	Kupfer	
feindrähtig	Min.			1 1,5mm ²	Kupfer	
feindrähtig	Max.			2 AWG 12	Kupfer	
feindrähtig	Max.			2 4mm ²	Kupfer	
feindrähtig	Min.			2 1,5mm ²	Kupfer	
ein- bzw. mehrdrähtig	Max.			2 AWG 10	Kupfer	
ein- bzw. mehrdrähtig	Max.			2 4mm ²	Kupfer	
feindrähtig mit Aderendhülsen nach DIN 46228	Min.			1 1mm ²	Kupfer	
feindrähtig mit Aderendhülsen nach DIN 46228	Max.			2 2,5mm ²	Kupfer	
feindrähtig mit Aderendhülsen nach DIN 46228	Min.			2 1mm ²	Kupfer	
Abisolierlänge des Leiters						
			Länge (mm) Anschlusslänge - Bild			
						
Empfohlene Schraubendreher						
Schraubendreherart			Wert			
Kreuzschlitz - Schraubendreher			PH1			
Schlitzschraubendreher nach DIN 5264			0,8x5,5			
Klemmschraube						
			Anzugsdrehmoment (Nm)		Anzugsdrehmoment (lb-in)	
			1		9	
Approbationen						
Specification						Marking
EAC						

Approbationen	Marking
Specification	
CE marking	
UK Directives	
CSA C.22.2 No.14	
GB/T14048.3	 GB/T14048.3

Allgemeine Informationen
Text
<ul style="list-style-type: none"> - Die Schaltgeräte sind wartungsfrei. Schmierung oder Behandlung von Kontakten ist zu unterlassen. - Die Schalter dürfen nur von Fachkräften und nach den anerkannten Regeln der Technik eingebaut, angeschlossen und in Betrieb genommen werden. - Nur Kupferleitungen verwenden. Leiterenden nicht verzinnen. - Klemmen mit werksseitig angeschlossenen Verbindungslaschen bzw. Drahtverbindungen werden verschraubt geliefert. Nach dem Öffnen solcher Klemmen ist darauf zu achten, dass keine Verbindungslaschen verloren gehen, alle Drahtverbindungen wieder korrekt sitzen und die Klemmschrauben mit dem angegebenen Drehmoment wieder festgezogen werden. - Nach Installation der Schalter müssen die Kriech- und Luftstrecken im Bereich der Anschlussklemmen den Anforderungen der anwendbaren Norm und Vorschriften entsprechen.

Waste Electrical & Electronic Equipment (WEEE)	
Picture name	Description
	Nicht in den Müll werfen, da auf eine umweltgerechte Entsorgung und Wiederverwertung geachtet werden muss. Bitte wenden Sie sich entweder an ein umweltfreundliches Entsorgungsunternehmen, senden Sie es zur Entsorgung an den Lieferanten oder direkt an den Hersteller Kraus & Naimer zurück. Lokale Kraus & Naimer Ansprechpartner finden Sie unter www.krausnaimer.com

Proposition 65	
Bildname	Beschreibung
	WARNING: This product can expose you to chemicals including nickel and lead, which is known to the State of California to cause cancer. For more information go to www.P65Warnings.ca.gov .

Kontakttype: Starre Kontaktbrücke
Kontaktmaterial: Silber
Anschluss: Schraubanschluss

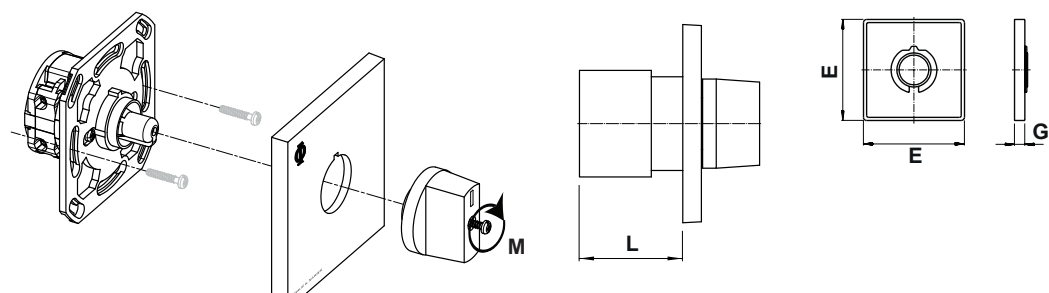
Mounting-UE1	
	
IP - Schutzart Front	IP40
Fluchten	2,00 - 2,00
E	□ 80,00 mm
G	H 7,50 mm
L	H 44,10 mm
M	M̄ 0,30 Nm

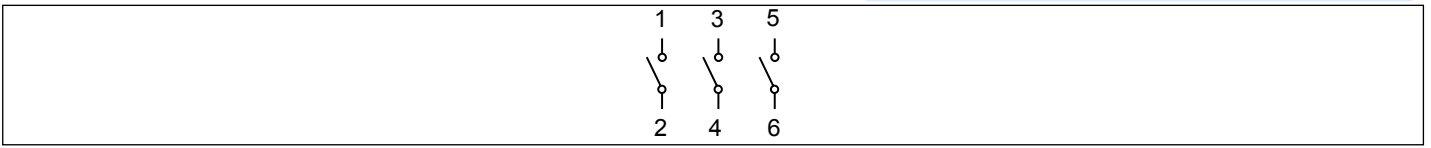

Anschlussbild

CA20.A202.UE1

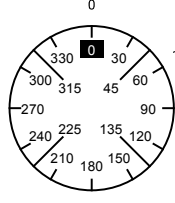

Schaltprogramm

CA20.A202.UE1

 Kraus & Naimer		CA20	A202	Seite 1 von 1											
Frontschild															
		1	3	5	7	9	11	13	15	17	19	21	23		
															
Schaltwinkel	60	2	4	6	8	10	12	14	16	18	20	22	24		
Gesamtschaltwinkel	60														
0	0														
	15														
	30														
	45														
1	60														
	75														
	90														
	105														
	120														
	135														
	150														
	165														
	180														
	195														
	210														
	225														
	240														
	255														
	270														
	285														
	300														
	315														
	330														
	345														

Version: 108

Frontschild

S1.F070/G10.UE1

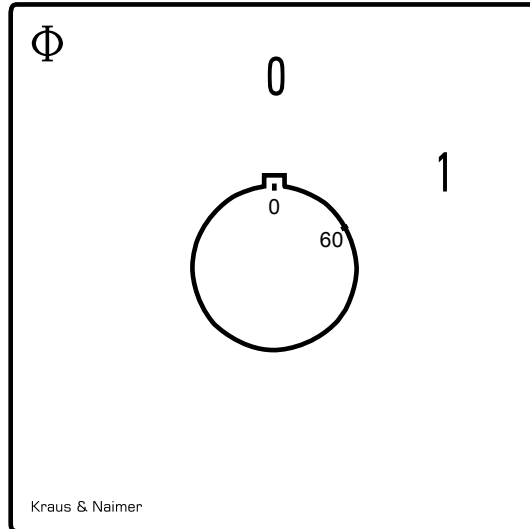

GRIFFE

Bezeichnung: S1B.G528

Grifffarbe: "8" weiss (für UE1)

