



Symbolbild



Datenblatt





Artikelnummer: 70005773

Bezeichnung: CA20.A401.PNL4

Beschreibung: Schalter

IEC 60947-3 EN 60947-3, VDE 0660 Teil 107						
Bemessungsisolationsspannung Ui						
			Spannung (V) AC / DC			
			690 AC / DC			
Bemessungsdauerstrom Iu/Ith						
Strom (A)	Umgebungstemperatur (°C)	Temperaturspitzen (°C)	zusätzliche Bedingungen			
25	55	60	Umgebungstemperatur +55°C über 24 Stunden mit Spitzen bis +60°C			
Bemessungsbetriebsstrom Ie						
Gebrauchskategorie		Spannung (V)			Strom (A)	
AC-15		220 - 240			8	
AC-15		380 - 440			5	
Bemessungsbetriebsleistung						
Gebrauchskategorie	Spannung (V)	Phasenanzahl	Polanzahl	Leistung (kW)		
AC-3	220 - 240	3	3	4		
AC-3	380 - 440	3	3	7,50		
AC-3	660 - 690	3	3	7,50		
AC-3	220 - 240	1	2	3		
AC-3	380 - 440	1	2	3,70		
AC-23A	220 - 240	3	3	5,50		
AC-23A	380 - 440	3	3	11		
AC-23A	660 - 690	3	3	11		
AC-23A	220 - 240	1	2	3		
AC-23A	380 - 440	1	2	5,50		
Maximaler Sicherungsnennstrom IEC						
Sicherungscharakteristik		Sicherungsanzahl			Strom (A)	
gG		1			35	
UL60947-4-1, UL508						
Nominal Voltage						
			Spannung (V) AC / DC			
			600 AC			
Bemessungsisolationsspannung Ui						
			Spannung (V) AC / DC			
			600 AC			
Rated thermal current						
Strom (A)		Umgebungstemperatur (°C)			Zusatz Text	
30		0 - 40			--	
Horsepower rating						
Across-the-Line Motor Starting		Spannung (V)	Phasenanzahl	Polanzahl	Leistung (HP)	Umgebungstemperatur [°C]
Reversing		110 - 120	1	2	0,33	40
Reversing		220 - 240	1	2	0,75	40
Reversing		277 - 277	1	2	1	40
Reversing		415 - 415	1	2	1,50	40
Reversing		440 - 480	1	2	2	40
Reversing		550 - 600	1	2	2	40
Reversing		110 - 120	3	3	1	40
Reversing		220 - 240	3	3	2	40
Reversing		415 - 415	3	3	3	40
Reversing		440 - 480	3	3	5	40
Reversing		550 - 600	3	3	5	40
DOL		110 - 120	1	2	1,50	40
DOL		220 - 240	1	2	3	40
DOL		277 - 277	1	2	3	40
DOL		415 - 415	1	2	3	40
DOL		440 - 480	1	2	5	40
DOL		550 - 600	1	2	5	40
DOL		110 - 120	3	3	3	40
DOL		220 - 240	3	3	7,50	40
DOL		415 - 415	3	3	7,50	40
DOL		440 - 480	3	3	10	40
DOL		550 - 600	3	3	10	40

Pilot duty rating code						
Duty Code						
A600						
SCCR / Max. Vorsicherung						
Conditions of acceptability						
These devices are suitable for use on circuits capable of delivering not more than 5000 rms symmetrical amperes, 600V ac max. when protected by Class RK1 fuses. Manual Motor Controllers when intended for use as a motor disconnecter are suitable for use on a circuit capable of delivering not more than 5000 rms symmetrical amperes, 600V ac max. when protected by 30A Class J time delay fuses.						
Temp. rating of wire						
Temperature Rating (°C)			Strom (A) Text			
75			– Use copper wire only			
Anschlussbestimmungen						
Markings						
When intended for use as a motor disconnecter the device shall be provided with a method of being locked in the OFF-position.						
General Use						
AC / DC	Spannung (V)	Strom (A)	Phasenanzahl	Polanzahl	Anzahl der Kontakte in Serie	
AC	600	30	1	2	1	
AC	600	30	3	3	1	
CSA						
Nominal Voltage						
			Spannung (V) AC / DC			
			600 AC			
Bemessungsisolationsspannung Ui						
			Spannung (V) AC / DC			
			600 AC			
Rated thermal current						
		Strom (A)		Umgebungstemperatur (°C) Zusatz Text		
		30		0 - 40 –		
Horsepower rating						
Across-the-Line Motor Starting						
	Spannung (V)	Phasenanzahl	Polanzahl	Leistung (HP)	Umgebungstemperatur [°C]	
DOL	110 - 120	1	2	1,50	40	
DOL	220 - 240	1	2	3	40	
DOL	277 - 277	1	2	3	40	
DOL	415 - 415	1	2	5	40	
DOL	440 - 480	1	2	5	40	
DOL	550 - 600	1	2	5	40	
DOL	110 - 120	3	3	3	40	
DOL	220 - 240	3	3	7,50	40	
DOL	415 - 415	3	3	10	40	
DOL	440 - 480	3	3	10	40	
DOL	550 - 600	3	3	10	40	
Pilot duty rating code						
Duty Code						
A600						
Temp. rating of wire						
Temperature Rating (°C)			Strom (A) Text			
75			– only			
General Use						
AC / DC	Spannung (V)	Strom (A)	Phasenanzahl	Polanzahl	Anzahl der Kontakte in Serie	
AC	600	30	1	1	1	
GENERAL TECHNICAL INFORMATION						
Klemmschraube						
			Anzugsdrehmoment (Nm)		Anzugsdrehmoment (lb-in)	
			1		9	
Abisolierlänge des Leiters						
			Länge (mm) Anschlusslänge - Bild			
			9 STRIPPINGLENGTH			
Leiterquerschnitt						
Leiteraufbau	Min. / Max. Wert		Anzahl der Leiter pro Klemme		Drahtquerschnitt (-bereich) (mm ²) oder (AWG/kcmil)	Drahtmaterial
eindrähtig	Min.		1		0,75mm ²	Kupfer
eindrähtig	Min.		2		0,75mm ²	Kupfer
feindrähtig	Min.		1		1,5mm ²	Kupfer
feindrähtig	Max.		2		AWG 12	Kupfer
feindrähtig	Max.		2		4mm ²	Kupfer
feindrähtig	Min.		2		1,5mm ²	Kupfer
ein- bzw. mehrdrähtig	Max.		2		AWG 10	Kupfer
ein- bzw. mehrdrähtig	Max.		2		4mm ²	Kupfer
feindrähtig mit Aderendhülsen nach DIN 46228	Min.		1		1mm ²	Kupfer
feindrähtig mit Aderendhülsen nach DIN 46228	Max.		2		2,5mm ²	Kupfer
feindrähtig mit Aderendhülsen nach DIN 46228	Min.		2		1mm ²	Kupfer
Approbationen						
Specification						Marking
EAC						
CE marking						

Approbationen		Marking
Specification		
UK Directives		
CSA C.22.2 No.14		
GB/T14048.3		
Empfohlene Schraubendreher		
<i>Schraubendreherart</i>	<i>Wert</i>	
Kreuzschlitz - Schraubendreher	PH1	
Schlitzschraubendreher nach DIN 5264	0,8x5,5	
Allgemeine Informationen		
<i>Text</i>		
<ul style="list-style-type: none"> - Die Schaltgeräte sind wartungsfrei. Schmierung oder Behandlung von Kontakten ist zu unterlassen. - Die Schalter dürfen nur von Fachkräften und nach den anerkannten Regeln der Technik eingebaut, angeschlossen und in Betrieb genommen werden. - Nur Kupferleitungen verwenden. Leiterenden nicht verzinnen. - Klemmen mit werksseitig angeschlossenen Verbindungslaschen bzw. Drahtverbindungen werden verschraubt geliefert. Nach dem Öffnen solcher Klemmen ist darauf zu achten, dass keine Verbindungslaschen verloren gehen, alle Drahtverbindungen wieder korrekt sitzen und die Klemmschrauben mit dem angegebenen Drehmoment wieder festgezogen werden. - Nach Installation der Schalter müssen die Kriech- und Luftstrecken im Bereich der Anschlussklemmen den Anforderungen der anwendbaren Norm und Vorschriften entsprechen. 		
Waste Electrical & Electronic Equipment (WEEE)		
<i>Picture name</i>	<i>Description</i>	
	Nicht in den Müll werfen, da auf eine umweltgerechte Entsorgung und Wiederverwertung geachtet werden muss. Bitte wenden Sie sich entweder an ein umweltfreundliches Entsorgungsunternehmen; senden Sie es zur Entsorgung an den Lieferanten oder direkt an den Hersteller Kraus & Naimer zurück. Lokale Kraus & Naimer Ansprechpartner finden Sie unter www.krausnaimer.com	
Proposition 65		
<i>Bildname</i>	<i>Beschreibung</i>	
	WARNING: This product can expose you to chemicals including nickel and lead, which is known to the State of California to cause cancer. For more information go to www.P65Warnings.ca.gov .	

Kontakttype: Starre Kontaktbrücke
Kontaktmaterial: Silber
Anschluss: Schraubanschluss

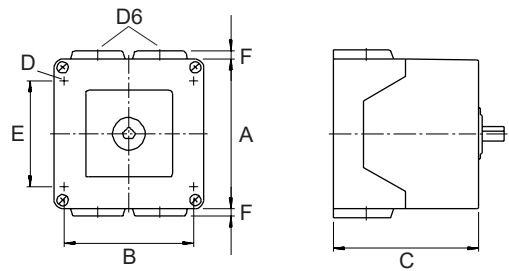
Bauform-PNL4		
		
IP - Schutzart Front		IP42
Fluchten		3,00 - 4,00
A	□	82,00 mm
B	H	68,00 mm
C	H	85,10 mm
D	∅	4,40 mm
D6	∅	4,00 x M25
E	H	52,00 mm
F	H	5,00 mm

Anschlussbild

CA20.A401.PNL4

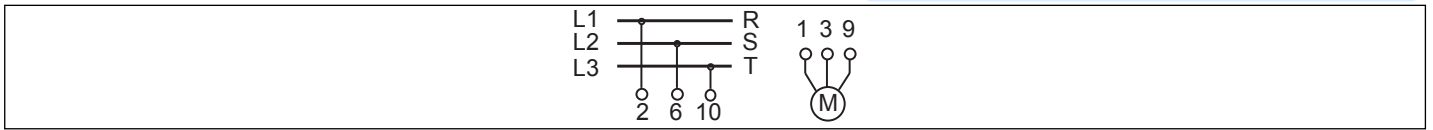

Schaltprogramm

CA20.A401.PNL4

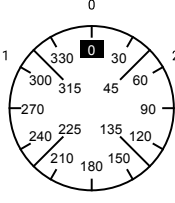
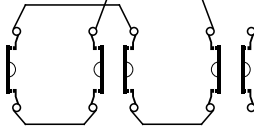
 Kraus & Naimer		CA20		A401		Seite 1 von 1							
		Frontschild											
		1	3	5	7	9	11	13	15	17	19	21	23
													
Schaltwinkel <input type="text" value="60"/>		2	4	6	8	10	12	14	16	18	20	22	24
Gesamtschaltwinkel <input type="text" value="120"/>													
1	300		■	■		■							
	315												
	330												
	345												
0	0												
	15												
	30												
	45												
2	60	■			■	■							
	75												
	90												
	105												
	120												
	135												
	150												
	165												
	180												
	195												
	210												
	225												
	240												
	255												
	270												
	285												

Version: 60

Frontschild

S1.F071/A10.PNL

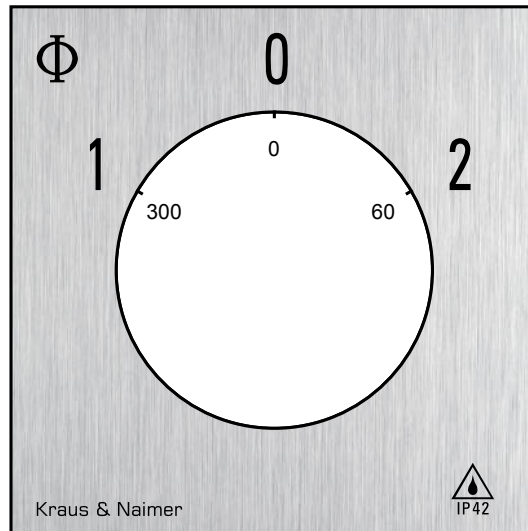

GRIFFE

Bezeichnung: S1B.G257

Grifffarbe: "7" elektro grau

